

Giunto semplice per canale di gronda $\varnothing 133$

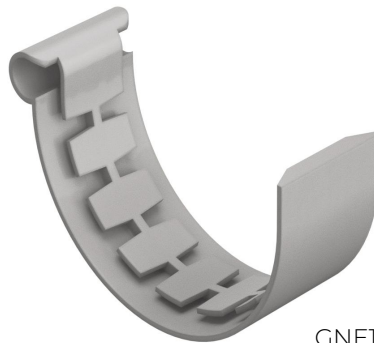

GNE133N

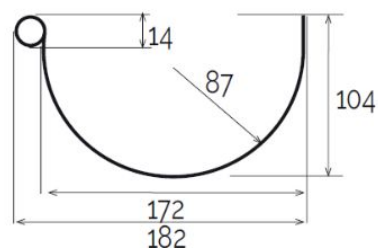
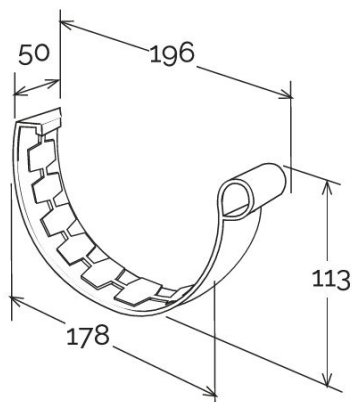

Sezione GRN133

Codice	Colore	lunghezza mm	larghezza mm	altezza mm	Peso g	Canale gronda abbinabile
GNE133B	bianco	196	50	113	78	GRN133B
GNE133N	grigio	196	50	113	78	GRN133N
GNE133S	sabbia	196	50	113	78	GRN133S

Materiale: PVC-U

Caratteristiche: Il giunto va incollato al canale di gronda inserendo questo negli appositi incavi. Utilizzare colla saldante per PVC (COFxxx), previa pulizia delle superfici.

