

## Testata sinistra per canale di gronda a doppia parete G2 **GROND PLAST**

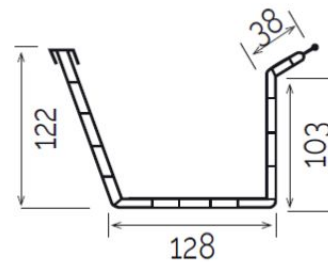
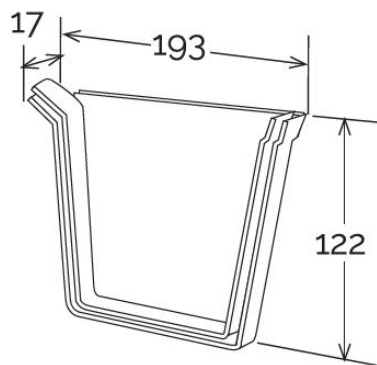

Sezione GRG2

Codice	Colore	lunghezza mm	larghezza mm	altezza mm	Canale gronda abbinabile
TSG2	marrone	193	17	122	GRG240

**Materiale:** PVC-U

**Caratteristiche:** La testata va incollata al canale di gronda inserendo questa all'estremità. Utilizzare colla saldante per PVC (COFxxx), previa pulizia delle superfici.

